

## L-CODED M12 POWER

SMALL SIZE, HIGH CAPACITY

Murrelektronik's L-coded M12 Power connectors are compact and powerful. As they become more and more established on the market they are quickly becoming the new standard. L-coded M12 Power connectors are a safe, pluggable connection for linear drives, stepper motors and fieldbus power supply modules. They are the alternative to 7/8" connectors for applications that require high power density in a compact space.



### Powerful, compact, flexible, safe and standardized

- Industry Standard Coded Connections according to IEC 61076-2-111
- UL-Listed Power Cable Assemblies for Industrial Machinery (PVVA – UL 2237)
- IP67 Rated
- Halogen-free PUR overmold
- Suitable for use in the toughest industrial applications
- Integrated vibration protection













### MEETS ALL INDUSTRIAL REQUIREMENTS

The connectors are molded with highly-resistant, halogen-free PUR material which makes them suitable for harsh industrial applications. The integrated conduit retainer ensures safe connections, even in applications that are exposed to shock or vibration.

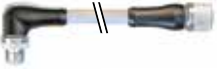
# M12 POWER, L-CODED

## ORDERING DATA

Open ended wires	Description	Style	Cable type (x)	Specification
	Male straight, 5 pole	7000-P4201-x	P04 P34	1,5 mm <sup>2</sup> 2,5 mm <sup>2</sup>
	Male straight, 4 pole	7000-P4101-x	P07 P37	1,5 mm <sup>2</sup> 2,5 mm <sup>2</sup>
	Male 90°, 5 pole	7000-P4211-x	P04 -	1,5 mm <sup>2</sup> -
	Male 90°, 4 pole	7000-P4111-x	P07 -	1,5 mm <sup>2</sup> -
	Female straight, 5 pole	7000-P4221-x	P04 P34	1,5 mm <sup>2</sup> 2,5 mm <sup>2</sup>
	Female straight, 4 pole	7000-P4121-x	P07 P37	1,5 mm <sup>2</sup> 2,5 mm <sup>2</sup>
	Female 90°, 5 pole	7000-P4231-x	P04 -	1,5 mm <sup>2</sup> -
	Female 90°, 4 pole	7000-P4131-x	P07 -	1,5 mm <sup>2</sup> -
Connection cables	Description	Style	Cable type (x)	Specification
	Male straight / Female straight, 5 pole	7000-P4241-x	P04 P34	1,5 mm <sup>2</sup> 2,5 mm <sup>2</sup>
	Male straight / Female straight, 4 pole	7000-P4141-x	P07 P37	1,5 mm <sup>2</sup> 2,5 mm <sup>2</sup>
	Male straight / Female 90°, 5 pole	7000-P4251-x	P04 -	1,5 mm <sup>2</sup> -
	Male straight / Female 90°, 4 pole	7000-P4151-x	P07 -	1,5 mm <sup>2</sup> -
	Male 90° / Female straight, 5 pole	7000-P4261-x	P04 -	1,5 mm <sup>2</sup> -
	Male 90° / Female straight, 4 pole	7000-P4161-x	P07 -	1,5 mm <sup>2</sup> -
	Male 90° / Female 90°, 5 pole	7000-P4271-x	P04 -	1,5 mm <sup>2</sup> -
	Male 90° / Female 90°, 4 pole	7000-P4171-x	P07 -	1,5 mm <sup>2</sup> -
Flange connectors	Description	Style	Cable type (x)	Specification
	Male, front wall mounting, 5 pole	7000-P4281-x	980 927	1,5 mm <sup>2</sup> 2,5 mm <sup>2</sup>
	Male, front wall mounting, 4 pole	7000-P4181-x	941 926	1,5 mm <sup>2</sup> 2,5 mm <sup>2</sup>
	Female, front wall mounting, 5 pole	7000-P4291-x	980 927	1,5 mm <sup>2</sup> 2,5 mm <sup>2</sup>
	Female, front wall mounting, 4 pole	7000-P4191-x	941 926	1,5 mm <sup>2</sup> 2,5 mm <sup>2</sup>
	Male, rear wall mounting, 5 pole	7000-P4285-x	980 927	1,5 mm <sup>2</sup> 2,5 mm <sup>2</sup>
	Male, rear wall mounting, 4 pole	7000-P4185-x	941 926	1,5 mm <sup>2</sup> 2,5 mm <sup>2</sup>
Image similar	Female, rear wall mounting, 5 pole	7000-P4295-x	980 927	1,5 mm <sup>2</sup> 2,5 mm <sup>2</sup>
Image similar		7000-P4195-x	941 926	1,5 mm <sup>2</sup> 2,5 mm <sup>2</sup>

Adapter	Description	Style	Cable type (x)	Specification
	M12 male / 7/8" female, 5 pole	7000-P4501-x	P04	1,5 mm <sup>2</sup>
	M12 male / 7/8" female, 4 pole	7000-P4504-x	P07	1,5 mm <sup>2</sup>
	M12 female / 7/8" male, 5 pole	7000-P4541-x	P34	2,5 mm <sup>2</sup>
	M12 female / 7/8" male, 4 pole	7000-P4544-x	P37	2,5 mm <sup>2</sup>
PushPull adapter	Description	Style	Cable type (x)	Specification
	M12 male / Aida PushPull, 5 pole	7000-P4451-x	P04	1,5 mm <sup>2</sup>
	M12 male / Aida PushPull, 4 pole	7000-P4454-x	P07	1,5 mm <sup>2</sup>
	M12 female / Aida PushPull, 5 pole	7000-P4471-x	P34	2,5 mm <sup>2</sup>
	M12 female / Aida PushPull, 4 pole	7000-P4474-x	P37	2,5 mm <sup>2</sup>
Distributor	Description	Style	Cable type (x)	Specification
	T-coupler, 1 x M12 male / 2 x M12 female	7000-P4901	-	-
			-	-
			-	-
	H-coupler, 1 x M12 male / 3 x M12 female	7000-P4902	-	-
			-	-
			-	-
	h-coupler, 1 x M12 male / 2 x M12 female	7000-P4903	-	-
			-	-
			-	-

## DIMENSION SKETCHES

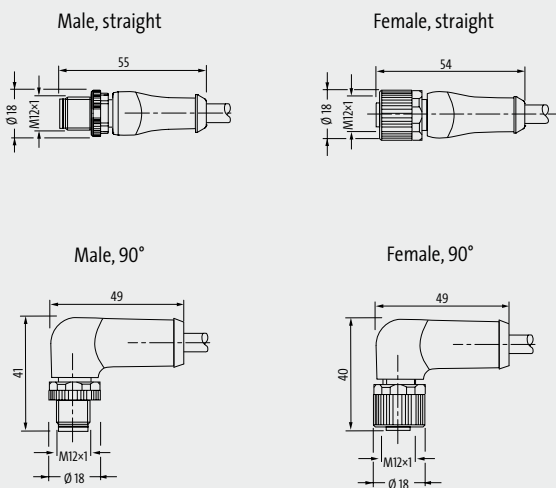

## TECHNICAL DATA

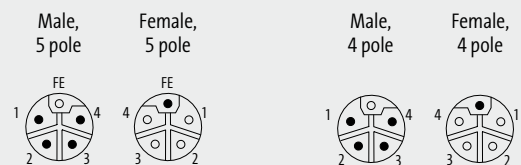

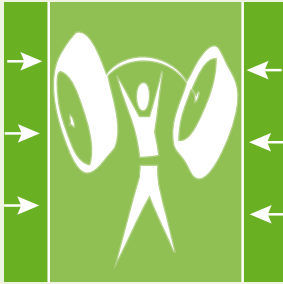

## HIGH PERFORMANCE IN A VERY SMALL SPACE

63 V AC/DC power transmission rates (up to 16 A continuous load) make them suitable for a wide range of applications.

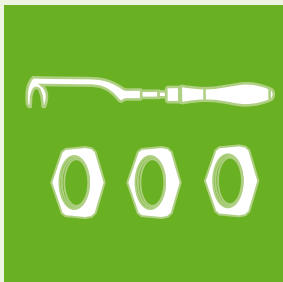

## QUICK AND SAFE ASSEMBLY

A coding arrow on the mold combined with a hex screw and nut make assembly easy. Using Murrelektronik's torque wrench (SW 17 / 0.6 Nm) ensures a properly sealed connection.



## SEALED AND SAFE CONTACTS

Gold-plated contacts guarantee safe power transmission. The full overmoulding of the connectors ensures that they are permanently sealed and IP67 rated.



## CONDUIT RETIANER OFFERS ADDITIONAL CABLE PROTECTION

An integrated, conduit retainer fits all standard tubings and helps provide an additional cable protection.